

# Multi KITA



**⚠ WARNING!**

Please read the manual in full before proceeding with the installation.

**I IMPORTANT NOTICES**

- To be able to monitor the panel remotely using a VNC programme, the home must have internet access, and the Kita Touch Multi Panel must be physically connected via network cable to the home router or switch.
- To configure the home network, some basic knowledge of network systems is required.
- In terms of network preparation, the external home Internet address can fall into one of 4 categories:
  - Static public IP
  - Dynamic public IP
  - Static private IP
  - Dynamic private IP

Instructions:

**Case A:** The ports must be forwarded from the public IP to the local private IP by acting on the router's NAT rules, VNC standard service port, TCP 5900, service port 8000

**Case B:** Same as A; it is also necessary to configure a dynamic DNS server account on the router, so that for each connection the chosen domain name is associated to the dynamic IP assigned by the provider.

**Case C and D:** A scratch card must be purchased to enable "Easy Access". Once active, this function lasts for the life of the panel, enabling access with a special client from PC and Smartphone without further configuration – you only need to enter your Easy Access username and password.

**Notes on setting up the system**

The panel requires power as shown below:

panel	24Vdc	700mA
-------	-------	-------

Provide adequate power supply to support the system, or use the HCC POW device.

MODBUS cable type: Templari HCC cable (type Belden 3105A 2x22AWG shielded)

Power supply cable type: 2x1 mmq

Power supply type: HCC POW 24Vdc, 2.5A

**Modbus data network connections****⚠ WARNING!**

We recommend the use of a HCC data CABLE

To correctly connect the Touch panel and the BMS board to each other, follow the instructions in Table 1 and Figure 1, taking care to connect the MODBUS cable sleeve to the earth socket of the 24Vdc power supply mounted on the machine.

BMS	Data cable	Multi Kita touch panel
GND		
+	A	A
-	B	B

Table 1

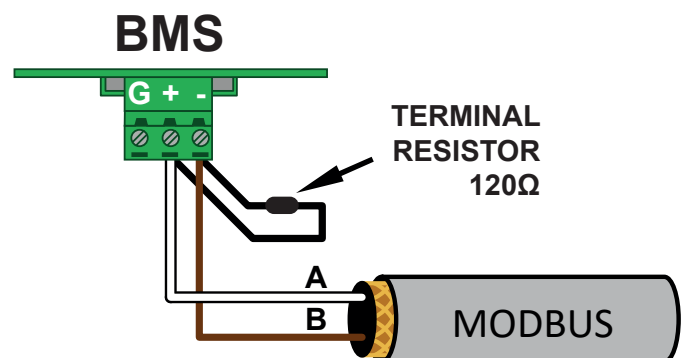

Figure 1

**⚠ WARNING!**

Installation note: MODBUS data wiring must **never** be carried out with direct Y- or star-forming shunts.

Peripheral devices must be connected to each other via "chain" connections, linking the heat pumps in sequence. It is therefore recommended to set up the cable feeding for 2 MODBUS data cables: the first is intended for the peripheral in use, and the second will be the return to connect the following peripheral.

- The chain network must be closed with a **120 Ohm terminating resistor at both ends**. One end must be the touch panel, the other end must be the last heat pump in the sequence.  
For wired data lines less than 10 metres long, use only one **120 Ohm terminating resistor**: either the one on the Multi Kita touch panel, or on the BMS board on the last heat pump in the chain.  
The resistor must be connected **between terminals A and B**.
- To use the Multi Kita system remotely via a VNC programme, the RJ45 port on the back of the Touch Panel must be connected to a Router or Switch via an Ethernet cable.



# Connecting the heat pumps to the network

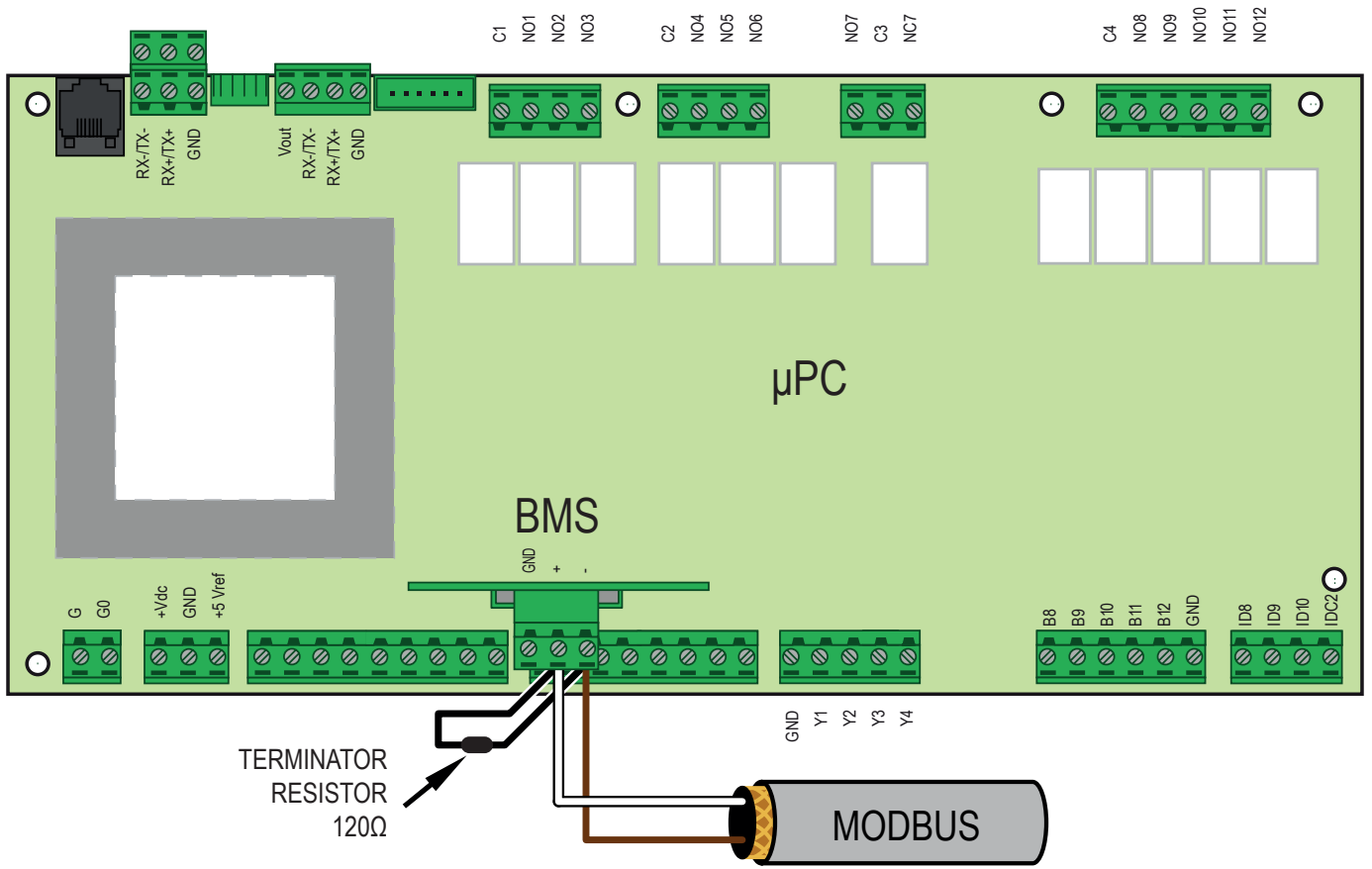

## Setting up the system

This version of Multikita installed on the Touch Panel replaces the previous version included in the heat pump software.

### Old version:

The previous version required all heat pumps to produce DHW or system water at the same time. This meant that the system could share return pipes.

### Current version:

The current version, on the other hand, manages the heat pumps independently, therefore it doesn't work with the previous systems; **each heat pump's supply and return must have a 3-way valve, i.e. 2 valves for each machine.**

This way, if one pump produces water for the system and another produces DHW, the return pipes will not mix the water.

### **⚠ WARNING!**

If the DHW function is enabled, for the Multikita to operate correctly each DHW-producing heat pump must have two 3-way valves, and supply and return must be independent for each pump.

## System diagram

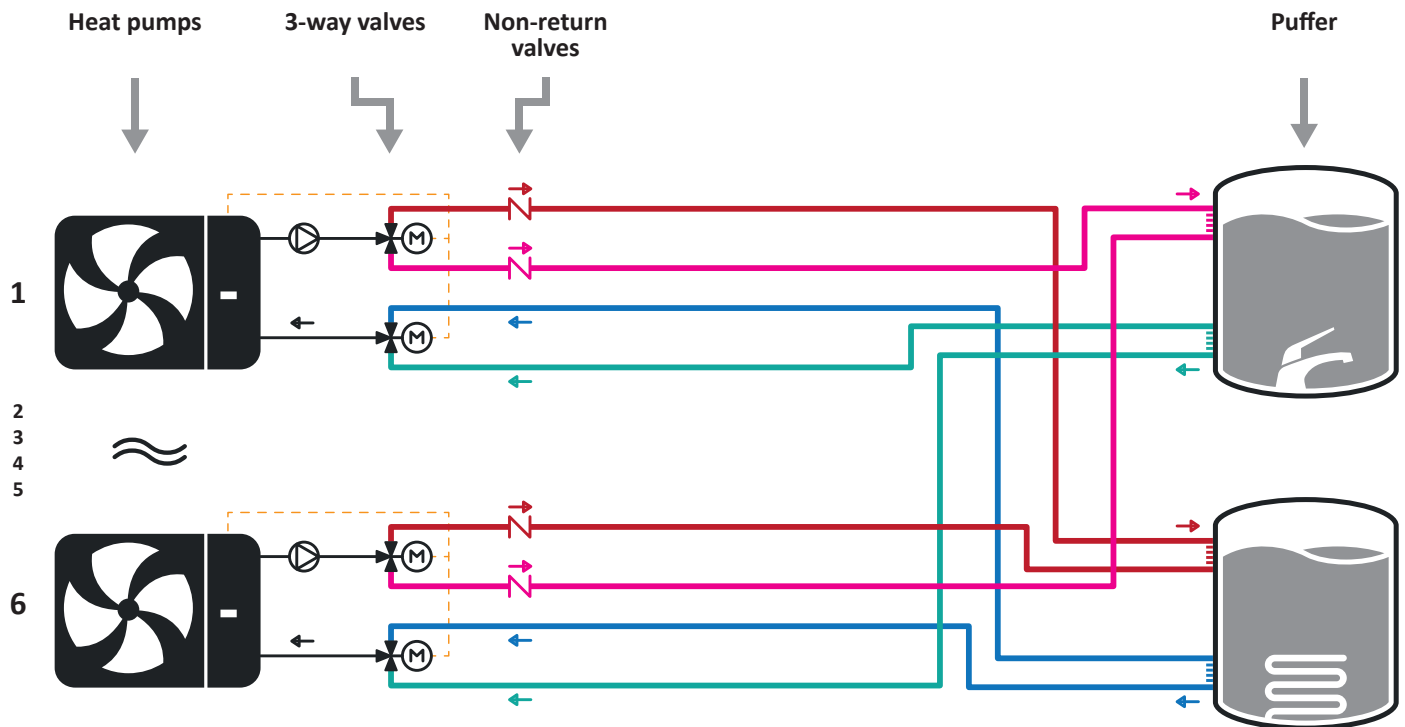

It is critical for the system to have 3-way valves for supply and return, as shown in the diagram. Each heat pump must have its own supply and return pipe to the puffer to avoid flow problems. **The Multikita system can't operate with a system built any other way.**

## Description of the Multikita system

### Purpose

Multikita is a touch panel programmed to operate several Kita heat pumps at the same time with a single control system, distributing the workload between them. The heat pumps connected to the system must have software version 13.13 or higher. Up to 6 heat pumps can be connected simultaneously. Some heat pumps can be designated as being connected to the system but not given permission to work; these pumps are referred to as "not enabled". You can keep some "non-enabled" heat pumps as backup in case of alerts or malfunctions of the other pumps. These pumps are referred to as "in stand-by". Only one pump, the one with Modbus address 1, will supply the sensors for all the others to work accordingly. The connected machines can be individually designated to produce only system water, only DHW, or both. **To ensure proper operation, the system must be set up as per the diagram on page 5.** The system's workload will be divided between the enabled pumps so that they can work at a low consumption and wear rate.

### Workload division

When one pump exceeds a certain working threshold, another starts, and they both work at a lower speed than the previous one. In the case of DHW production, the system searches for the supplementary pump first among those that can only do DHW, and then among the hybrid ones that can do both DHW and system water. In the case of system water production, there are no restrictions in the choice of supplementary machines: the system can add a pump that does exclusively system water, or a hybrid one.

### Menu



- 1 Open/close the menu bar.
- 2 Overview screen.
- 3 Setpoint screen.
- 4 System preferences screen.
- 5 CMix preferences screen.
- 6 Programs screen.
- 7 Alert list screen.

### Screens

#### Overview

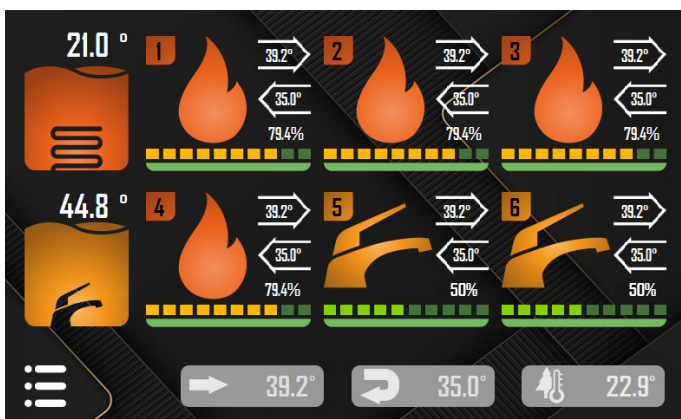

The overview screen shows how many heat pumps are installed and enabled. For each pump, identified with a number from 1 to 6, the supply and return temperatures are reported. The visual appearance indicates the working status. The coloured bar indicates the degree to which the compressor is working, expressed as a percentage.

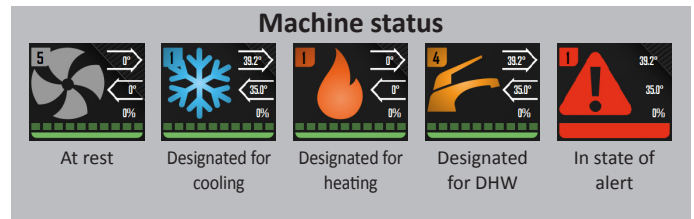

Once a pump has been assigned to a job, it may be a few minutes before the compressor starts. As soon as the pump starts working, the percentage bar will load according to the intensity of work of the compressor.



This button opens the menu for navigating between screens.



Supply temperature (B7 sensor). In cooling mode, this will show the lowest temperature of all supply probes among the enabled working pumps. Conversely, in heating mode, it will show the highest temperature.



Return temperature (B4 sensor). In cooling mode, this will show the lowest temperature of all return probes among the enabled working pumps. Conversely, in heating mode, it will show the highest temperature.



External temperature (B8 probe).

### Setpoint

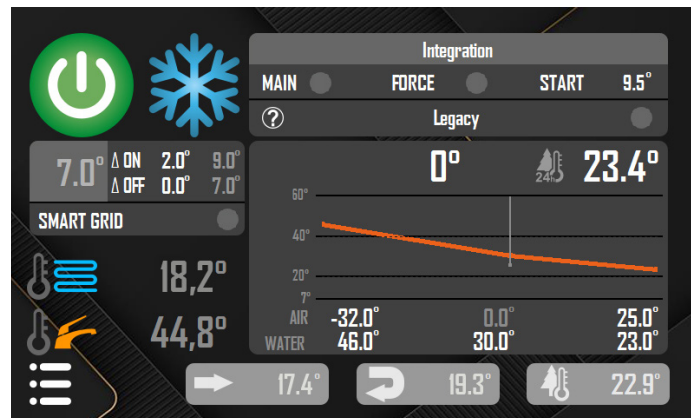

This screen shows the sensors used to regulate system operation.



Turning the system on and off. Red means off; green means on. When the system is off, the heat pumps cannot start.

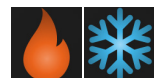

Working mode. The Flame symbol means the system is in heating mode; the Snowflake means it is in cooling mode. If the system is in heating mode, the climate curve can be activated (see below).



The higher value represents the currently active setpoint, while  $\Delta ON$  and  $\Delta OFF$  represent the on/off hysteresis.

If the setpoint becomes highlighted in blue, this means there was a problem with the probes and as a safety precaution the system was switched off. By tapping on the setpoint you can access the Setpoint screen.

**SMART GRID**

Smart Grid refers to the electricity supplier being able to cut power at certain times. Pressing this button notifies the system that this is the case, so any communication errors are reset every 5 minutes.

18,2°  
44,8°

The upper value is the system water puffer temperature (probe B2), while the lower one, if enabled, is that of the DHW puffer sensor (probe B3). These sensors are used to regulate the operation of the system.

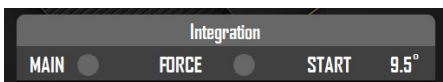
**Integration**

The Multikita can be supplemented by a resistor. This function works separately for system water and for DHW.

**Integration****Integration**

This section in the Setpoint screen is dedicated to the control of an external resistor, which can be connected to the *K-DINAUX3 expansion board to manage auxiliary resistors for the DIN rail*. The external resistor is supplied separately (for installation see diagram on page 3). When the heading is highlighted in blue, the resistor is in operation.

The resistor is activated if the system is out of set and the forcing is active, or if the system is in demand and at least one of the following conditions is true: the outside temperature is below the activation threshold (START); a machine is in defrost state; a machine is in alert state.

**MAIN**

This is the general button which activates the integration function of the external resistor. If this is switched off, the resistor will **never** turn on.

**FORCE**

Resistance forcing. If this button is on, as soon as the system is out of set, the resistor turns on.

**START**

Switch-on threshold. If the outside temperature falls below this value and the system is in demand, then the resistor turns on.

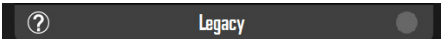
**Legacy**

If you want to use the Multikita simultaneously for system water and DHW, but the system does not have 3-way valves on the return circuit (meaning all return pipes are common for all machines), the only way is to activate the legacy function. In this case, all pumps **must** be enabled for DHW (see Settings chapter on page 8). Once the legacy function is enabled, when the system is producing system water, all machines will produce exclusively system water; when the system is producing DHW, all machines will produce exclusively DHW.

**Legacy**

The button on the right activates the Legacy function.

**Legacy**

Pressing the "?" button will display a summary screen explaining what the system should look like to function properly.

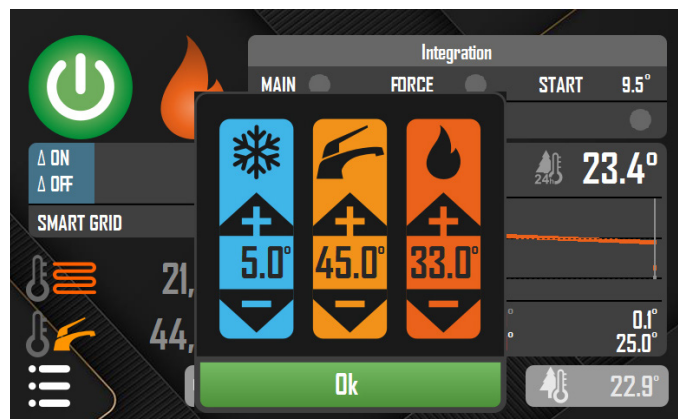
**Setpoint**

On this screen you can enter the setpoints for cooling, heating and domestic hot water. These setpoints are valid for the whole system.

**Climate curve**

In this section of the screen you can activate the climate curve and set its operating thresholds.

The climate curve function adjusts the setpoint based on the outside temperature, calculated on an average of the last 24 hours, so that the heat pumps work harder only when needed.

**! WARNING!**

If you decide to use this function, make sure that the heat pump's own climate curve is disabled.

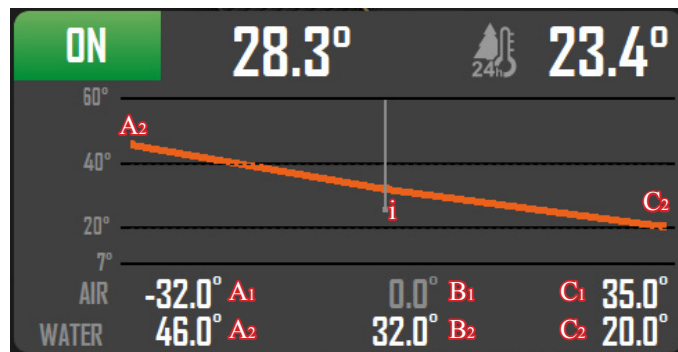
**Diagram.**

The climate curve only works in heating mode and calculates a Delta which will be combined with the setpoint in use.

**A<sub>1</sub>**. The lower average outside temperature in the diagram. At or below this outside temperature, the starting setpoint for the Delta calculation will be the temperature indicated by **A<sub>2</sub>**.

**B<sub>1</sub>**. Average outside temperature of 0°. At an outside temperature of 0° the desired temperature for the Delta calculation will be **B<sub>2</sub>**.

**C<sub>1</sub>**. The highest average outdoor temperature in the diagram. At or above this outside temperature, the setpoint for Delta calculation will be **C<sub>2</sub>**.

The climate curve graph shows on the y axis the temperature to be reached, and on the x axis the average outside temperature.

The graph shows a curve (red line) which intersects (point i) with the current average outside temperature (white line). The leftmost point on the curve (A<sub>2</sub>) represents the desired maximum supplied temperature, and the rightmost point (C<sub>2</sub>) is the desired minimum temperature. The delivered temperature difference (A<sub>2</sub>-i) is the final Delta, which will be combined with the current setpoint.

This means that if the current setpoint is the same as  $A_2$ , then the graph will correspond to the current operation settings; but if the setpoint changes, the effect is similar to shifting the curve.

ON

**Activation.** By pressing the icon it is possible to activate or deactivate the climate curve. Once activated, the final setpoint will change according to the curve and the average outside temperature.

23.4°

**Outside temperature.** It shows the average outside temperature calculated over 24 hours. This value is used as a parameter for calculating the climate curve.

28.3°

**Final setpoint.** Once the climate curve is activated, the base setpoint will be changed by the delta. The result is the new setpoint that will be used by the heat pump.

## Settings

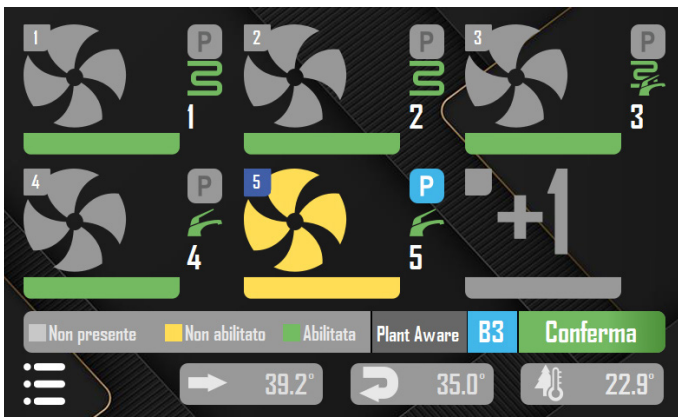

In the settings screen, you can set the number of heat pumps connected to the system. Each heat pump will have a preset address, from 1 to 6, which identifies it in the MODBUS network and cannot be changed.

By tapping on a connected pump it is possible to change its status: absent (grey), not enabled (yellow), enabled (green). By pressing the side buttons, it is also possible to specify the job to which it is assigned: system water only, DHW only, or both.

The P button indicates whether the pump is in stand-by. For the pump in stand-by to operate correctly, it **must** also be displayed as *non-enabled*, and have the highest address.

After each change, the CONFIRM button must be clicked to save the changes made.

If the DHW probe (B3) has been installed, pressing the B3 button will display its value in the Overview and Setpoint screens.

**Plant Aware:** The purpose of this function is to reduce the number of times the system turns on and off by activating a SLEEP mode when no connected devices are in demand. When SLEEP mode is active, 10° are added to the power-on hysteresis of the system.

The function can also be enabled and disabled from the PGD1 panel (Gfc 65 form), but enabling or disabling it from the MultiKita Touch panel overrides it.

Plant Aware can have 2 scenarios:

1. cMix boards are installed.

If no boards are in demand, SLEEP mode is activated; if at least one is in demand (i.e. at least one relay is closed, and at least one circulator is running), SLEEP mode is not active.

2. no cMix boards are installed.

In this case, probe B5 of the primary pump must be enabled. The system will check the status of digital input ID 10 of the  $\mu$ Pc. If the contact is closed, SLEEP mode is activated. In this way, the

activation of SLEEP mode is decided by a logic external to the panel.

40.0°  $\Delta$  ON  
 $\Delta$  OFF 0.5° 40.5°

If SLEEP mode is on, then in the Setpoint screen,  $\Delta$ ON will turn blue and the hysteresis will disappear, indicating that it's been overridden.

## Alerts



The alert screen shows the list of alerts that have occurred. Specifically, if a pump has generated an alert, then the corresponding button will appear in the lower section. Pressing it will initiate the procedure of resetting alerts for that pump. If a communication alert has occurred between the panel and a heat pump, then the corresponding light will turn on. Before resetting any alerts you must press the light and reset the communication alert, or it won't be possible to reset the other ones.

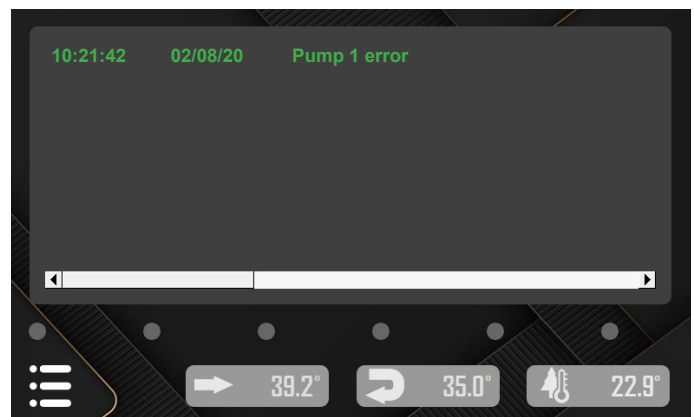

When the alerts are reset, the red text turns green.

Some of the heat pump alerts turn off automatically. For this reason, the system periodically interrogates the heat pumps to find out whether the alert has been reset. If it has, this event is always reported on this screen and the relevant alerts are reset.

## Replacing pumps in state of alert

If there are any pumps in standby in the system (i.e. designated as *non-enabled and in standby*), if a machine issues an alert it will be replaced by one of the standby pumps, as follows:

- A pump designated for system water production can only be replaced by another designated for the same, or by one designated for both system and DHW.
- A pump designated for DHW production can only be replaced by another designated for the same, or by one designated for both DHW and system water.
- A pump designated for both system water and DHW production can only be replaced by another designated for the same.



## CMix summary screen

In this screen any external CMix boards can be added and their function parameters can be set.

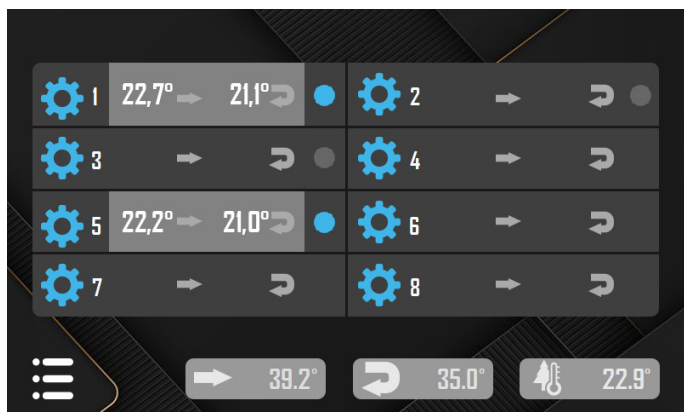

The purpose of the CMix boards is to mix system water in the system, where necessary.

For a complete guide on how to install the CMix board, please read the manual supplied with it.



When the CMix card is not installed, the only thing visible will be the blue gear symbol and the board number. Clicking on the gear symbol will open the **CMix settings** screen, from which you can add the CMix board and set its working parameters (see below).



Once the board is installed, a button will appear to its right, with which you can enable it to work. **At this point, the system will still not use the installed board unless it is enabled first.** When the button is clicked, it turns blue to indicate that the board is enabled.



When the board is enabled, the Multikita system will work with it. A grey button will appear on the line, with the supply and return temperatures read by the probes from the CMix board. Clicking the button will switch to the summary screen of the **workflow** of that CMix board. (see below)

## CMix settings

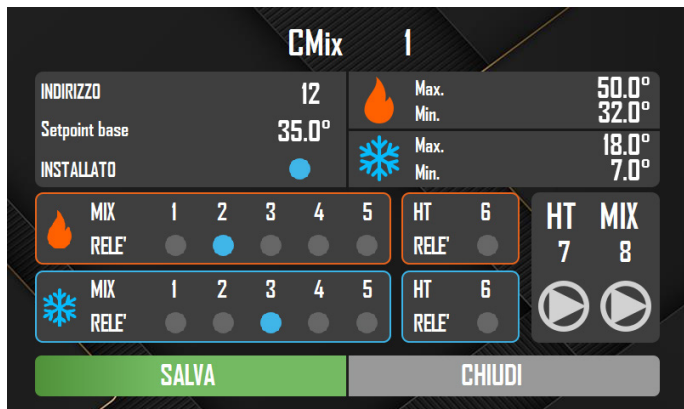

In this screen, you can set the operating parameters of the CMix board.

For more details see the guide provided with the board.

## CMix workflow

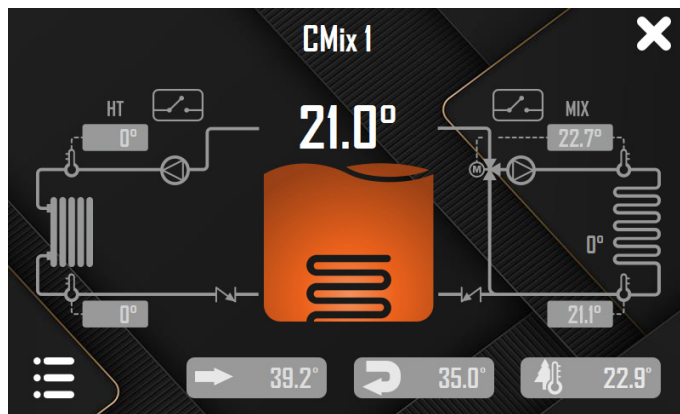

In this screen you can monitor the work of the CMix board. For more details see the guide provided with the board.

## Programming

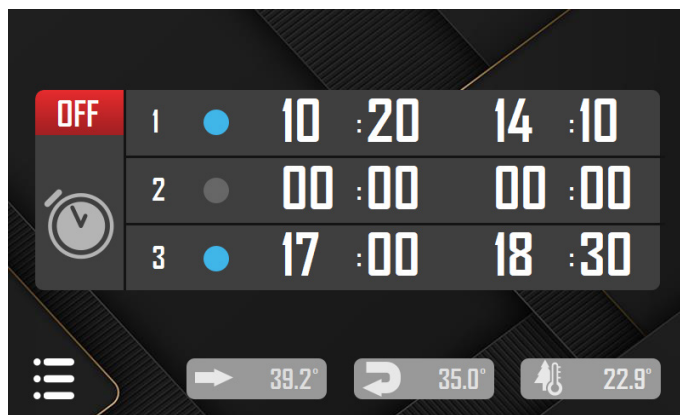

Up to 3 time slots can be set in this screen. During an enabled time slot, the system can switch the heat pumps on, otherwise it switches them off.

**OFF** **Activation.** By pressing the icon, programming can be activated or deactivated. Once activated, the enabled time slots will be used to switch the system on and off.

**1** **Enabling.** By tapping the icon it is possible to enable or disable the corresponding time slot. The blue icon indicates an enabled time slot, while the grey icon represents a disabled one.



**Time slot.** The time on the left indicates the start of the on state, while the time on the right indicates the end.

 When programming is enabled, a clock appears in the Setpoint screen next to the On/Off button. If the clock is grey, programming will force the system to be Off. If the clock is yellow, programming will force the system to be On.

This is independent of the actual state of the On/Off button.



Templari Srl  
Via Pitagora, 20/A - 35030 Rubano (PD) - Italy  
Tel +39 049 8597400 | Fax +39 049 8055626  
info@templari.com - www.templari.com - P. IVA 04128520287